



FX29

Compact Compression Load Cell

Versatile Miniature Force Sensor

mV, Amplified, and Digital Outputs

Low Power Consumption

Rugged Microfused Sensing Element

Stainless Steel Enclosure

Several Load Ranges

Features

- Compact Design
- mV or Amplified Analog Outputs
- Optional I²C Digital Interface
- High Over Range Capability

Applications

- Medical Infusion Pumps
- Analog & Digital Scales
- Fitness & Exercise Equipment
- Payload Weighing
- Power Tools
- Robotics
- Surgical & Dental Tools
- Battery Powered Devices
- Manufacturing Equipment

TE Connectivity's (TE) FX29 is a compact compression load cell that offers exceptional price-to-performance in a robust sensor package. Optimized for embedded force sensing applications from disposable medical devices to durable appliances and exercise equipment. The FX29 allows design flexibility with mV, amplified, and digital output options.

The FX29 incorporates the high reliability Microfused technology and is offered in ranges from 10lbf to 200lbf (50N to 1000N). Microfused technology provides excellent span and zero stability, outstanding cycle life, superior resolution, high over-range capabilities, and an unamplified span sensitivity of 20mV/V.

The FX29 utilizes a two-piece construction of stainless steel materials. The combination of a metal injection molded flexure and micro miniaturized MEMS strain gauges allows flexibility of force range options for a lower cost sensor. These improvements over previous load cell designs give the FX29 more precise dimensional control and better performance.

[CLICK HERE >](#)
CONNECT WITH A SPECIALIST

Absolute Maximum Ratings (Analog) ⁽¹⁾

Parameter	Symbol	Min	Typ	Max	Units	Notes/Conditions
Supply voltage	V _{dd}			6.0	V	Analog mV Output
				5.25	V	Analog 0.5-4.5V Output
Storage temperature	T _s	-40		+85	°C	
Compressive load	L _{max}			2.5X	Rated	
ESD		-4.0		4.0	kV	Human Body Model

⁽¹⁾ Maximum limits the device will withstand without damage

Standard Load Ranges

Pounds-Force (lbf)	Newtons (N)
10	50
25	125
50	250
100	500
200	1000

Electrical Specifications (Analog)

(Unless otherwise specified, all parameters are measured at 25°C @ 5.0V applied)

Parameter	Symbol	Min	Typ	Max	Units	Notes/Conditions
Supply voltage (V _{supply})	V _{dd}	1.00		6.0	V	mV Output only
		4.75		5.25	V	0.5-4.5V Output only
Operating current	I _{dd}			3	mA	0.5-4.5V Output only
Input resistance	R _{in}	2.4	3.0	3.6	kΩ	mV Output only
Output resistance	R _{out}	1.76	2.2	2.64	kΩ	mV Output only
Rise time	T _r			2.0	ms	10% to 90%
Maximum output current	I _o	2.2			mA	0.5-4.5V Output only
Output short circuit duration	T _s			∞	seconds	0.5-4.5V Output only
Insulation resistance		50			MΩ	@250VDC
Bandwidth				1.0	kHz	

Operating Specifications (Analog)

(Unless otherwise specified, all parameters are measured at 25°C @ 5.0V applied)

Parameter	Symbol	Min	Typ	Max	Units	Notes/Conditions
Zero offset ¹		-15		15	mV/V	mV Output only
		300	500	700	mV	0.5-4.5V Output only
Full scale span ¹		16	20	24	mV/V	mV Output only
		3800	4000	4200	mV	0.5-4.5V Output only
Non-linearity		-1		1	%Span	BFSL
Hysteresis		-0.8		0.8	%Span	
Zero repeatability		-0.8		0.8	%Span	
Span repeatability		-0.8		0.8	%Span	
Thermal shift for zero		-0.05		0.05	%Span/°C	Reference to 25°C, over compensated temperature
Thermal shift for span		-0.05		0.05	%Span/°C	
Cycle life		1E+6				0 to full scale cycles
Deflection at rated load				0.03	mm	
Weight			6.0		grams	Without ribbon cable

⁽¹⁾ Span and zero offset are ratiometric to power supply voltage

Environmental Specifications (Analog)

(Unless otherwise specified, all parameters are measured at 25°C @ 5.0V applied)

Parameter	Symbol	Min	Typ	Max	Units	Notes/Conditions
Compensated temperature range	T _o	0		50	°C	0.5-4.5V Output only
Storage temperature	T _s	-40		85	°C	
Ambient humidity		0		85	%RH	Non-condensing
EMI/RFI/ESD protection		IEC61000-4-2 (8kV _{air} /4kV _{contact}) IEC61000-4-3 (3V/m) EN55032 Class A				mV Output only
Ingress protection	IP		43			
Media compatibility		External exposed surfaces: 17-4 and 304 stainless steel				Excluding cable & connector

FX29

Compact Compression Load Cell

Schematic Diagram – mV output (Analog)

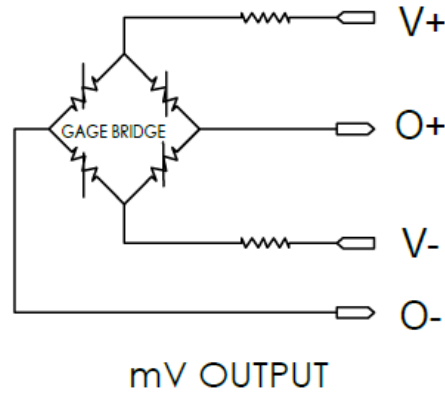

Block Diagram – 0.5 to 4.5V output (Analog)

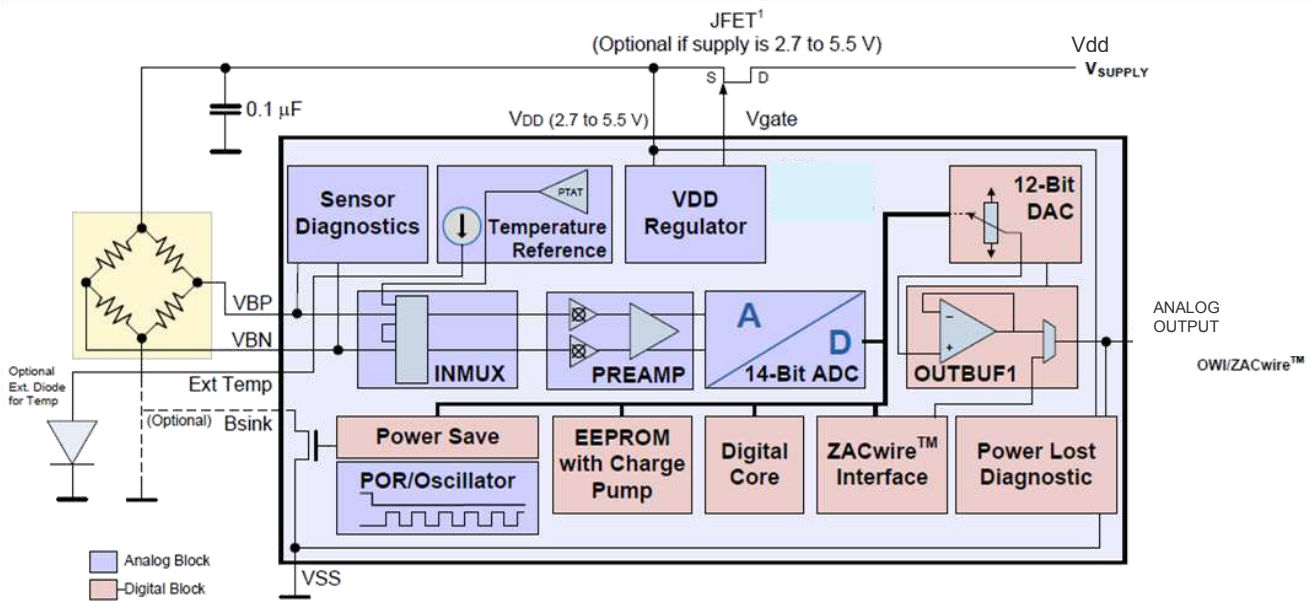

FX29

Compact Compression Load Cell

Absolute Maximum Ratings (Digital) ⁽¹⁾

Parameter	Symbol	Min	Typ	Max	Units	Notes/Conditions
Supply voltage				5.50	V	
Storage temperature	T _s	-40		+85	°C	
Compressive load	L _{max}			2.5X	Rated	
ESD		-4.0		4.0	kV	Human Body Model

⁽¹⁾ Maximum limits the device will withstand without damage**Standard Load Ranges**

Pounds-Force (lbf)	Newtons (N)
10	50
25	125
50	250
100	500
200	1000

Electrical Specifications (Digital)

(Unless otherwise specified, all parameters are measured at 25°C @ 3.0V applied)

Parameter	Symbol	Min	Typ	Max	Units	Notes/Conditions
Supply voltage (V _{supply})	V _{dd}	2.7		5.5	V	
Operating current	I _{dd}			3	mA	
Sleep mode current	I _{sp}		0.5	5	µA	
Insulation resistance		50			MΩ	@250VDC

FX29

Compact Compression Load Cell

Force Operating Specifications (Digital)

(Unless otherwise specified, all parameters are measured at 25°C @ 3.0V applied)

Parameter	Symbol	Min	Typ	Max	Units	Notes/Conditions
Zero offset		300	1000	1700	Counts	Base ₁₀
Full scale span		14300	15000	15700	Counts	Base ₁₀
Non-linearity		-1		1	%Span	BFSL
Hysteresis		-0.8		0.8	%Span	
Zero repeatability		-0.8		0.8	%Span	
Span repeatability		-0.8		0.8	%Span	
Thermal shift for zero		-0.05		0.05	%Span/°C	Reference to 25°C, over compensated temperature
Thermal shift for span		-0.05		0.05	%Span/°C	
Cycle life		1E+6				0 to full scale cycles
A/D resolution			14		Bits	
Response time				3	mS	4MHz, non-sleep mode
				8.4	mS	4MHz, sleep mode
Deflection at rated load				0.03	mm	
Weight			6.0		grams	Without ribbon cable

Environmental Specifications (Digital)

(Unless otherwise specified, all parameters are measured at 25°C @ 3.0V applied)

Parameter	Symbol	Min	Typ	Max	Units	Notes/Conditions
Compensated temperature range	T _o	0		50	°C	
Storage temperature	T _s	-40		85	°C	
Ambient humidity		0		85	%RH	Non-condensing
Ingress protection	IP	43				
Media compatibility		External exposed surfaces: 17-4 and 304 stainless steel				Excluding cable & connector

FX29

Compact Compression Load Cell

Block Diagram – I²C Digital Output (Digital)

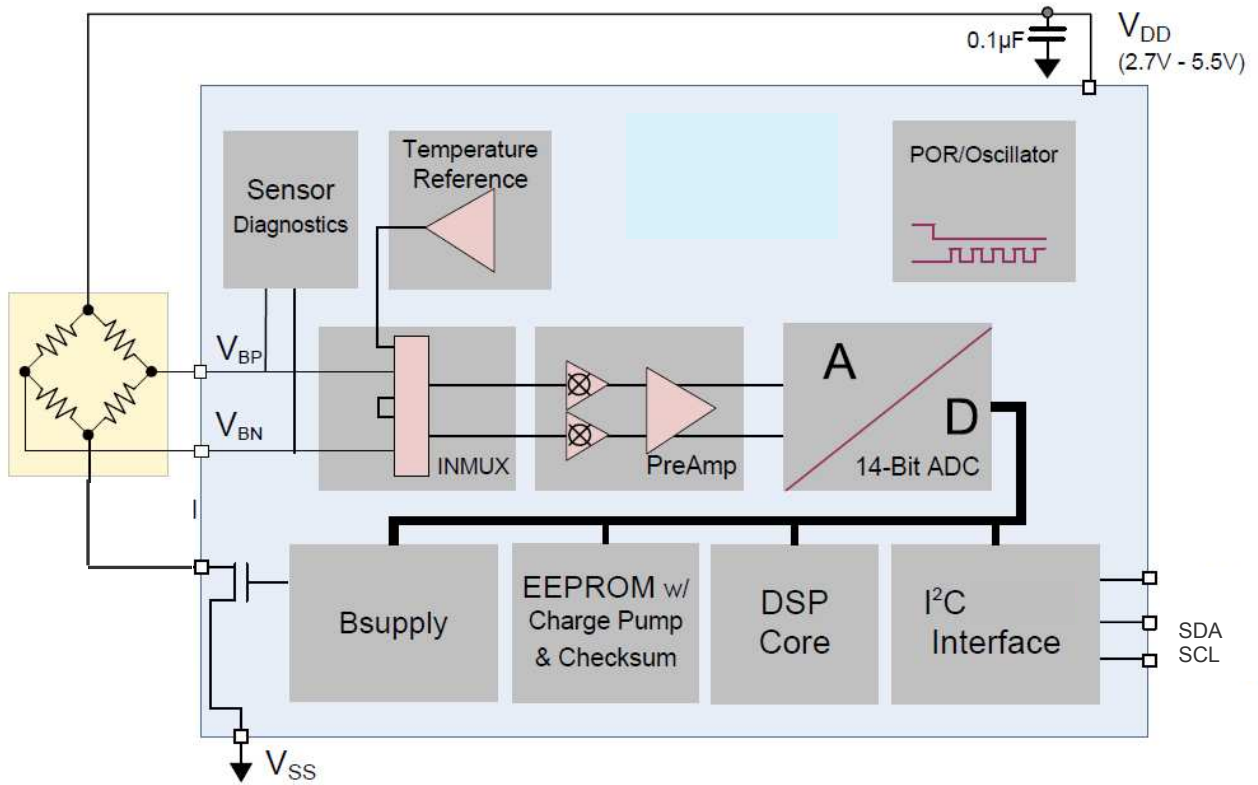

FX29

Compact Compression Load Cell

Force Output Graph (Digital)

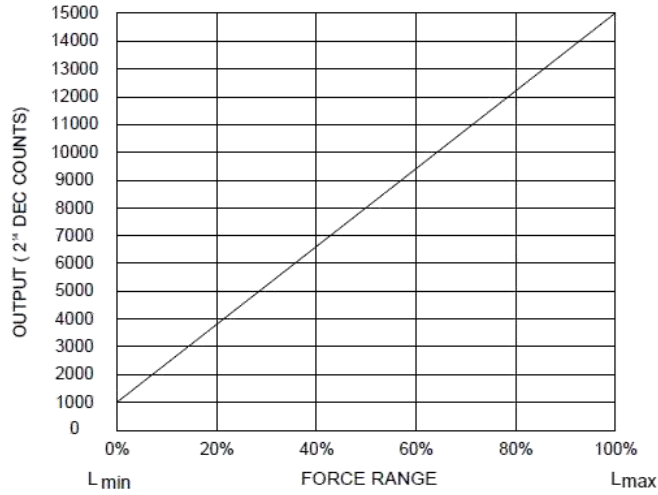

$$OUTPUT \text{ (decimal counts)} = \frac{14000}{LOAD \text{ RANGE}} * FORCE + 1000$$

Force Sensor Output

%Output	Counts (decimal)	Counts (hex)
0%	1000	0x3E8
5%	1700	0x6A4
10%	2400	0x960
50%	8000	0x1F40
90%	13600	0x3520
95%	14300	0x37DC
100%	15000	0x3A98

I²C Typical Circuit

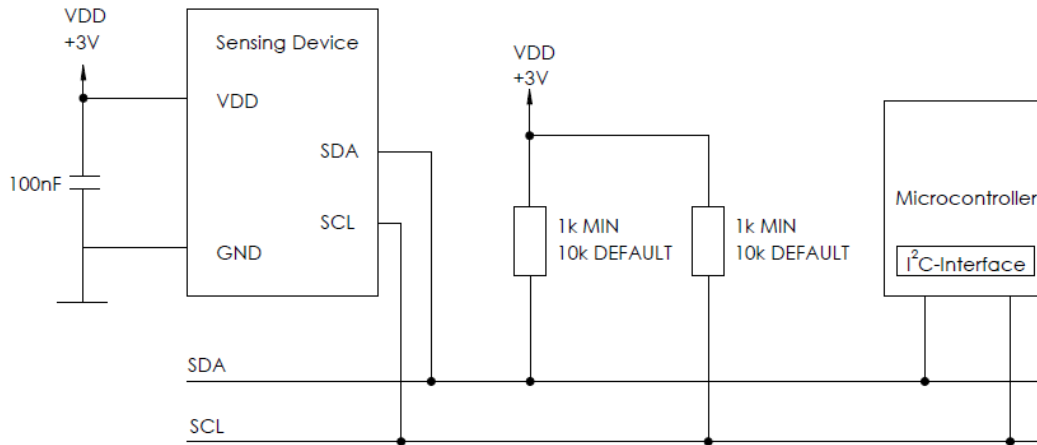

Note: only one pair of pull up resistors are needed for multiple sensing devices.

FX29

Compact Compression Load Cell

I²C Interface

Parameter	Symbol	Min	Typ	Max	Units	Notes/Conditions
SCLK clock frequency	F _{SCL}	100		400	kHz	
Start condition hold time relative to SCL edge	t _{HOSTA}	0.1			μS	
Minimum SCL clock low width ¹	t _{LOW}	0.6			μS	
Minimum SCL clock high width ¹	t _{HIGH}	0.6			μS	
Start condition startup time relative to SCL edge	t _{SUSTA}	0.1			μS	
Data hold time on SDA relative to SCL edge	t _{HDDAT}	0			μS	
Data setup time on SDA relative to SCL edge	t _{SUDAT}	0.1			μS	
Stop condition setup time on SCL	t _{SUSTO}	0.1			μS	
Bus free time between stop and start condition	t _{BUS}	2			μS	

I²C Interface Timing Diagram

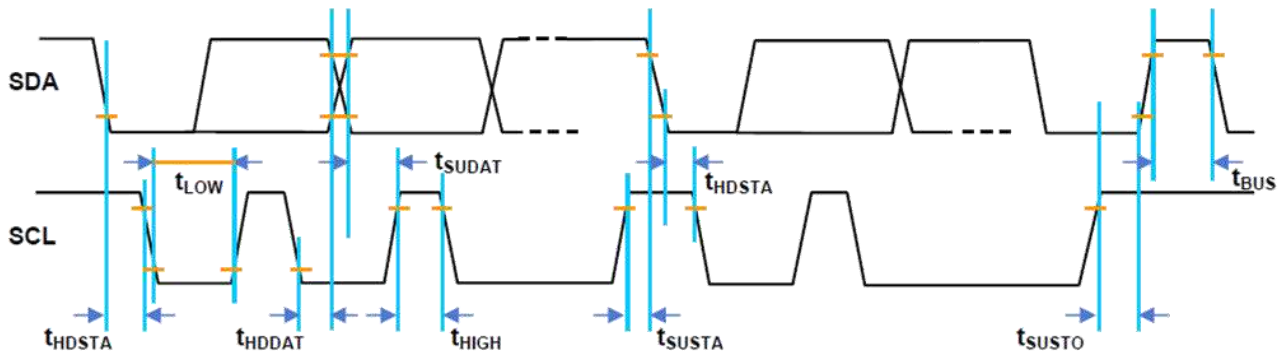

Digital Input and Output Parameters

(Unless otherwise specified, all parameters are measured at 25°C @ 3.0V applied)

Parameter	Symbol	Min	Typ	Max	Units	Notes/Conditions
Input high voltage	V _{IH}	0.8		1.0	x V _{DD}	
Input low voltage	V _{IL}	0.0V		0.2	x V _{DD}	
Output low level					x V _{DD}	
Load capacitance @ SDA				200	pF	@400 kHz
Input capacitance (each pin)				10	pF	

I²C Measurement Packet Read Sequence

(1) I²C Read_MR – Measurement Request:
Slave starts a measurement and DSP calculation cycle.

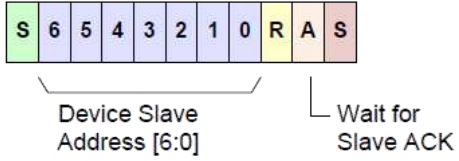

(2) I²C Read_DF2 – Data Fetch 2 Bytes:
Slave returns only bridge data to the master in 2 bytes.

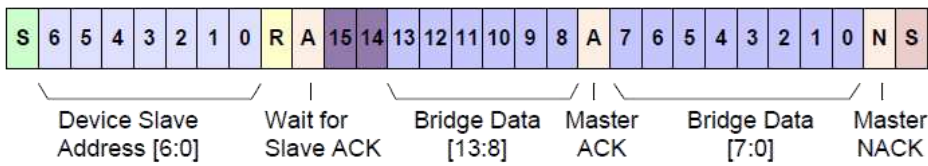

- S Start Condition
- 5 Device Slave Address (example: Bit 5)
- 2 Data Bit (example: Bit 2)
- R Read/Write Bit (example: Read=1)
- A Acknowledge (ACK)
- N No Acknowledge (NACK)
- S Stop Condition
- Status Bit

General Working Mode

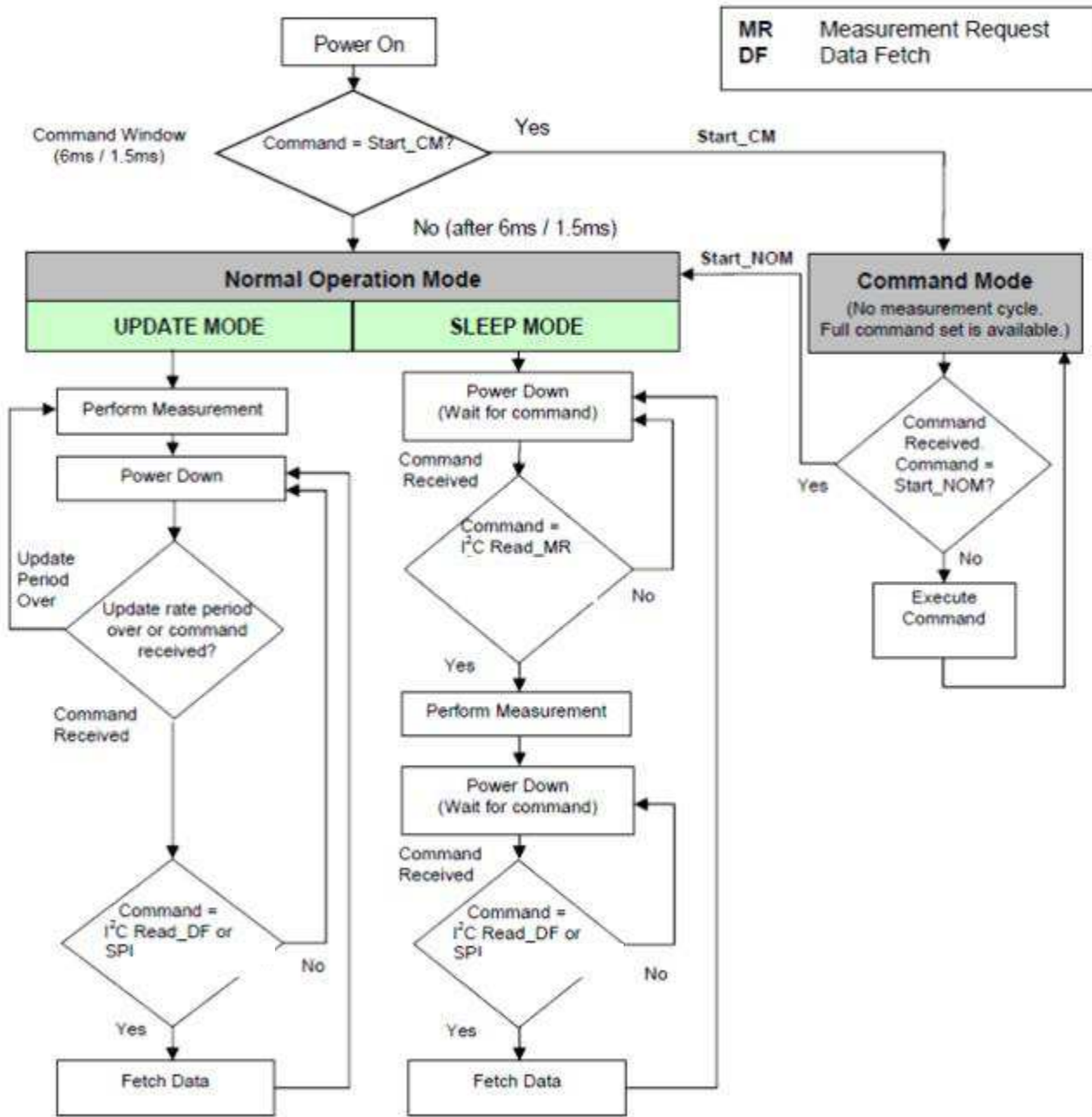

FX29

Compact Compression Load Cell

Outline Drawing and Connections

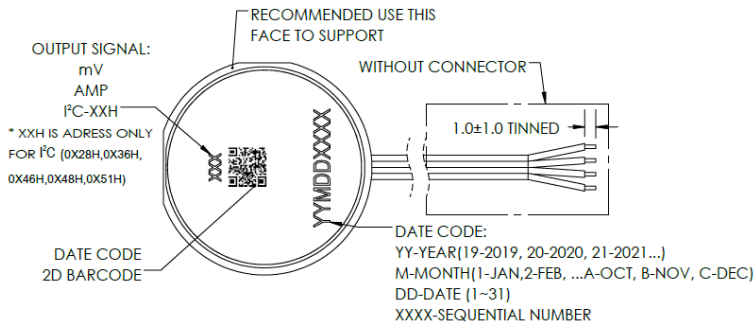
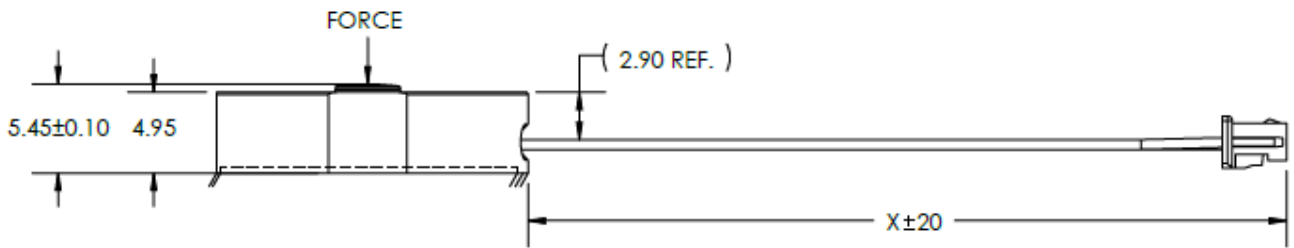
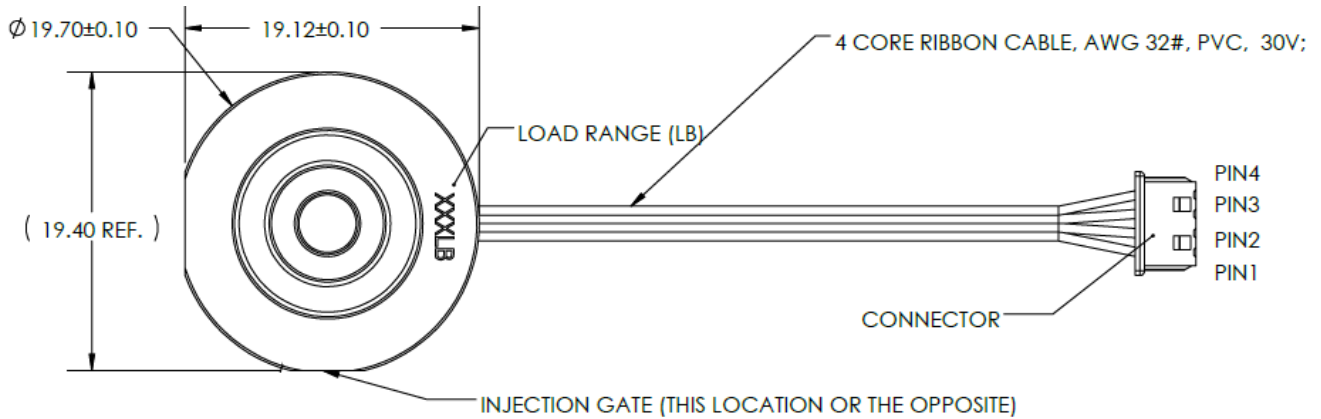

CONNECTIONS INFORMATION:

PIN	WIRE COLOR	OUTPUT SIGNAL		
		mV	0.5~4.5V	I ² C
4	RED	V+	V+	V+
3	YELLOW	O+	O+	SCL
2	WHITE	O-	N/A	SDA
1	BLACK	V-	COMMON	V-

CONNECTOR INFORMATION:

BRAND	PART	DESCRIPTION	MATING RECOMMENDATION
TE	HOUSING	TE: # 440146-4, CONN RCPT 4POS SGL 1.25MM NATRL	TE: # 1734598-4, CONN HEADER VERT 4POS 1.25MM
	TERMINAL	TE: # 1734193-1, CONN SOCKET 28-32AWG CRIMP TIN	

mV OUTPUT

WIRING INFORMATION

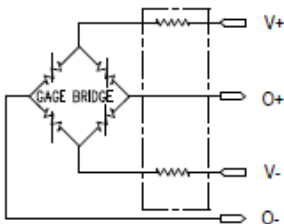

0.5~4.5V OUTPUT

WIRING INFORMATION

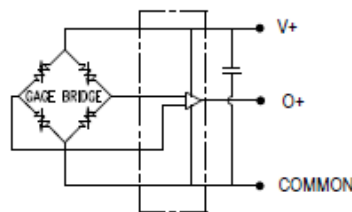

I²C OUTPUT

WIRING INFORMATION

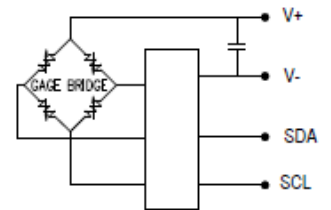

FX29

Compact Compression Load Cell

Mounting Recommendation

The sensor can be put into a simple slot fixture for load testing. The load should be applied to the spherical face of center boss. Recommended to stick the sensor with double face 3M adhesive or glue. Some feature to clamp the sensor from top to down can be optional.

See below for reference:

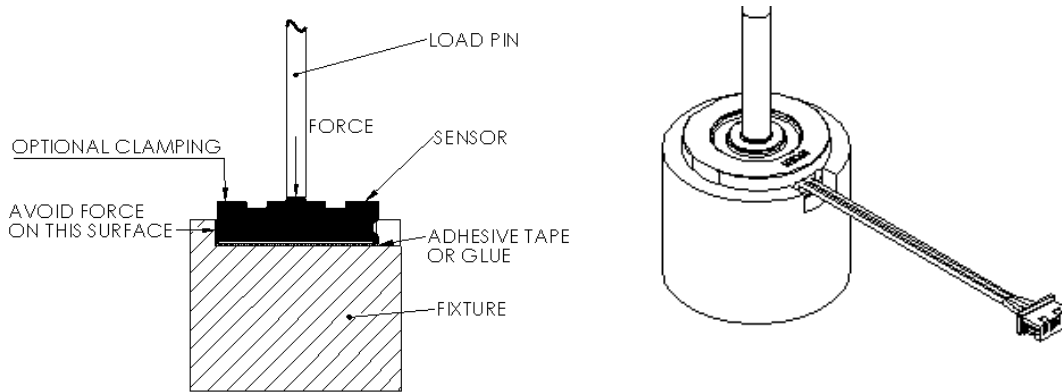

NOTE: Clamping force may shift the zero reading slightly. Re-zero if needed.

Below table shown the Zero change difference when loaded 5 Lbf from the top. (For reference only)

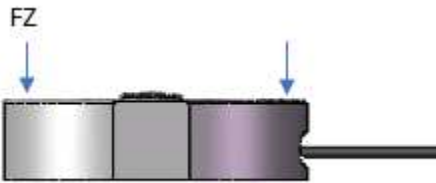

Load Range	10L	25L	50L	100L
Changing for reference	±0.5%FS	±0.4%FS	±0.35%FS	±0.25%FS

Dimension for reference:

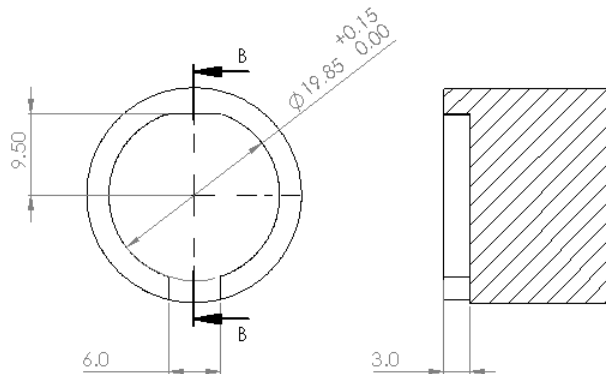

FX29

Compact Compression Load Cell

Ordering Information

FX29 X X - XXX X - XXXX - X

Output Signal		
Code	Output	Output Type
2	20 mV/V*	mV
3	0.5 – 4.5V*	Amplified
J	I ² C (None Sleep)	Digital
K	I ² C (Sleep)*	Digital

I ² C Address	
Code	Device Address (hex)
X	Analog Output*
0	0x28*
1	0x36
2	0x46
3	0x48
4	0x51

Cable Length	
Code	Length
040	40 mm*
100	100 mm*
XXX	Custom Length

Measurement Units	
L	Pounds-force (lbf)*
N	Newton

Load Range	
LBF	Newton
0010*	0050
0025*	0125
0050*	0250
0100*	0500
0200* (MACHINING)	1000

Cable & Connector	
Code	Cable and Connector
A	4-wire ribbon cable without connector
B	4-wire ribbon cable with connector*

Note: For digital output, ensure custom cable length does not exceed 1 meter.

*Sensor features shown in **bold** are typically stocked by our distribution partners, or available with short lead times from the factory depending on availability. Contact customer service for details.

Caution:

For the digital sensor. User can change the address along with the guide as below link.

Please notice, any data changed by users means users give up the quality assurance terms. TE will not guarantee the sensor performance any more.

https://www.te.com/commerce/DocumentDelivery/DDEController?Action=showdoc&DocId=Specification+Or+Standard%7FDIGITAL_MODEL_S_CHANGING_I2C_SLAVE_ADDRES%7FA1%7Fpdf%7FEnglish%7FENG_SS_DIGITAL_MODELS_CHANGING_I2C_SLAVE_ADDRES_A1.pdf%7FCAT-PTT0015

FX29

Compact Compression Load Cell

REVISION HISTORY

Revision Number	Change Description	Date	Approval
A3	Minor corrections ;	06/24/2019	MH
A4	Correct pin numerical to be same as connector	07/29/2020	MH
A5	Mounting Recommendation and Caution added;	10/27/2020	MH

[CLICK HERE >](#)
CONNECT WITH A SPECIALIST

NORTH AMERICA
Tel +1 800 522 6752

EUROPE
Tel +31 73 624 6999

ASIA
Tel +86 0400 820 6015

te.com/sensors

Microfused, Measurement Specialties (MEAS), TE Connectivity, TE, TE Connectivity (logo) and Every Connection Counts are trademarks. All other logos, products and/or company names referred to herein might be trademarks of their respective owners

The information given herein, including drawings, illustrations and schematics which are intended for illustration purposes only, is believed to be reliable. However, TE Connectivity makes no warranties as to its accuracy or completeness and disclaims any liability in connection with its use. TE Connectivity's obligations shall only be as set forth in TE Connectivity's Standard Terms and Conditions of Sale for this product and in no case will TE Connectivity be liable for any incidental, indirect or consequential damages arising out of the sale, resale, use or misuse of the product. Users of TE Connectivity products should make their own evaluation to determine the suitability of each such product for the specific application.

© 2020 TE Connectivity Corporation. All Rights Reserved.

Mouser Electronics

Authorized Distributor

Click to View Pricing, Inventory, Delivery & Lifecycle Information:

[TE Connectivity:](#)

[20009605-14](#)